

Loman



	Seduta - Seat	Schienali - Backrests	Struttura - Structure	
Rivestimento Upholstering (10)	Sfoderabile / Removable Non sfoderabile / Not removable	Sfoderabile / Removable Non sfoderabile / Not removable	Sfoderabile / Removable Non sfoderabile / Not removable	
Imbottiture Padding (2-4-5-6-7-8)	Tecnoform D.30kg/m³	Misto piuma	Tecnoform	 Optional

INFORMAZIONI TECNICHE

Struttura: 1

Masselli portanti in abete di vari spessori. Fianchi di tamponamento in pannelli di particelle di legno in classe E1, particolari in pannelli di fibra di legno dura o cellulosa.

Molleggio: 1-3

Schienale in pannelli di fibra di legno dura o cellulosa. Seduta in nastri elastici di fibra propilenica e lattice.

Note:

Supporti dello schienale (9) in metallo rivestiti in tessuto, similpelle o pelle sfoderabile. Libreria, piano o tavolino in acciaio verniciato.

TECHNICAL INFORMATION

Structure: 1

Supporting structure in pinewood of various thicknesses. Remaining parts in class E1 particleboard panels, hardboard or cellulose wood-based panels details.

Springing: 1-3

The back is made of hard or cellulose wooden fibre panels. The seat is supported by propylene and latex elastic belts.

Note:

Metal back support (9) covered with fabric, simil leather or removable leather. Laquered steel bookcase, top or small table.

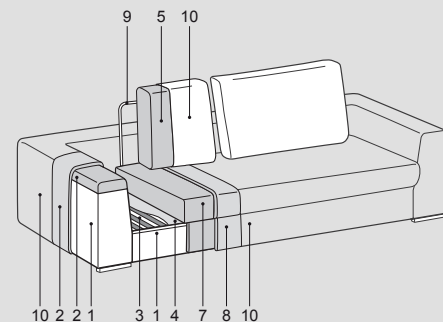
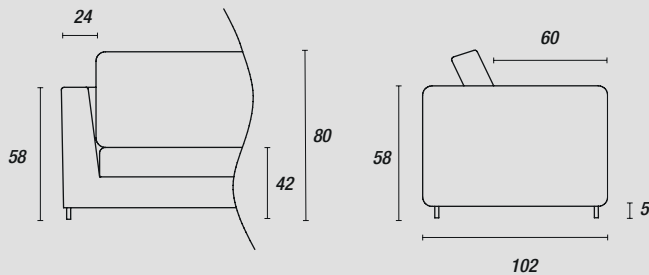

Piedini - Feet:

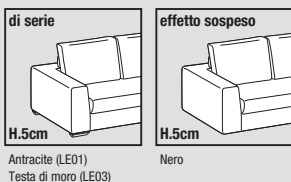







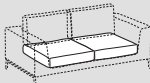
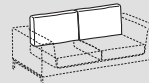
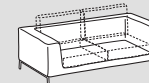

Accessori - Accessories:



Loman soft



	 Seduta - Seat	 Schienali - Backrests	 Struttura - Structure	
Rivestimento Upholstering (10)	Sfoderabile Removable 	Sfoderabile Removable 	Sfoderabile Removable 	
	Non sfoderabile Not removable -	Non sfoderabile Not removable -	Non sfoderabile Not removable -	
Imbottiture Padding (2-4-5-6-7-8)	 Tecnoform D.30kg/m³	 Misto piuma	 Tecnoform	 Optional

INFORMAZIONI TECNICHE

Struttura: 1

Masselli portanti in abete di vari spessori. Fianchi di tamponamento in pannelli di particelle di legno in classe E1, particolari in pannelli di fibra di legno dura o cellulosa.

Molleggio: 1-3

Schienale in pannelli di fibra di legno dura o cellulosa. Seduta in nastri elastici di fibra propilenica e lattice.

Note:

Supporti dello schienale (9) in metallo rivestiti in tessuto, similpelle o pelle sfoderabile. Libreria, piano o tavolino in acciaio verniciato.

TECHNICAL INFORMATION

Structure: 1

Supporting structure in pinewood of various thicknesses. Remaining parts in class E1 particleboard panels, hardboard or cellulose wood-based panels details.

Springing: 1-3

The back is made of hard or cellulose wooden fibre panels. The seat is supported by propylene and latex elastic belts.

Note:

Metal back support (9) covered with fabric, simil leather or removable leather. Laquered steel bookcase, top or small table.

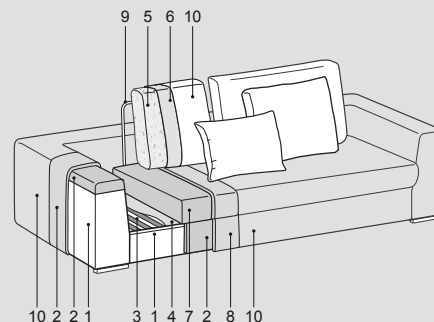
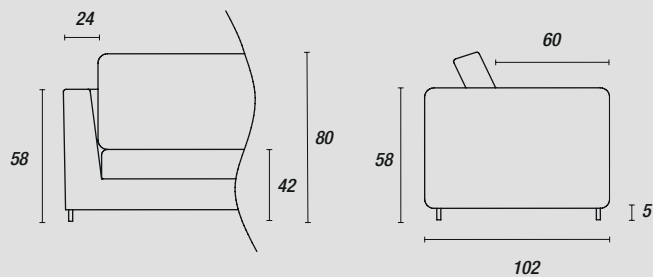

Piedini - Feet:

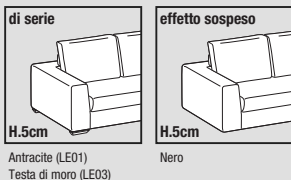

Accessori - Accessories:

