

## Avarit

Giuseppe Viganò



Personalizzazione è la parola chiave che caratterizza la collezione di divani componibili Avarit. E' possibile disegnare la composizione desiderata partendo da una base ed uno schienale fissi a cui vengono aggiunti degli importanti cuscini di seduta e schienale in piuma che rappresentano la vera e propria anima del divano. E' possibile inoltre scegliere all'interno di un'ampia gamma di rivestimenti in tessuto e pelle, da abbinare in totale libertà. I piedini sono in metallo verniciato grigio antracite, tortora, marrone, bianco o nero.

### RIVESTIMENTO:

tessuto

pelle

### PIEDINI:

metallo verniciato grigio antracite

metallo verniciato tortora

metallo verniciato marrone

metallo verniciato bianco opaco

metallo verniciato nero opaco

Divano 322 - variante A  
Sofa

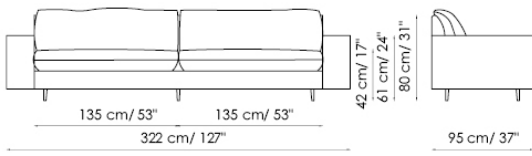

Divano 322 - variante B  
Sofa

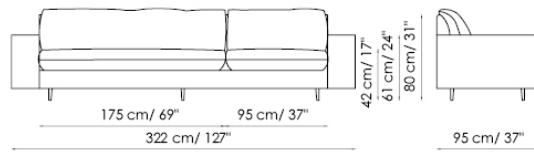

Divano 282 - variante A  
Sofa

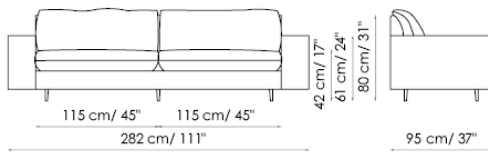

Divano 282 - variante B  
Sofa

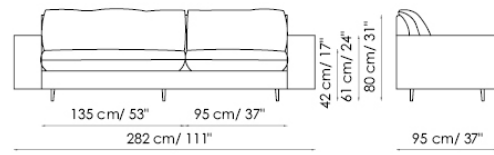

Divano 242  
Sofa

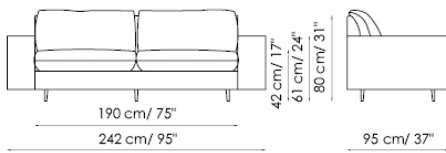

Divano 227  
Sofa

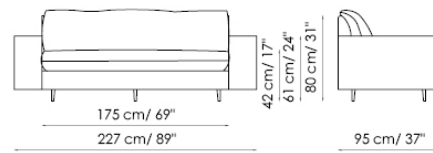

Divano 207  
Sofa

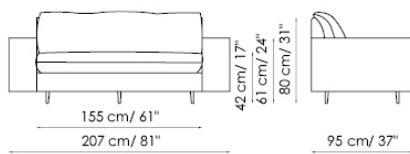

Divano 187  
Sofa

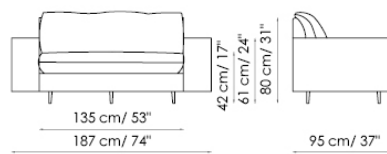

Terminale 256  
End section sofa

sx  
left

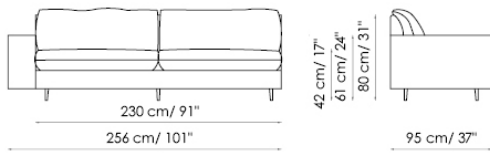

Terminale 216  
End section sofa

sx  
left

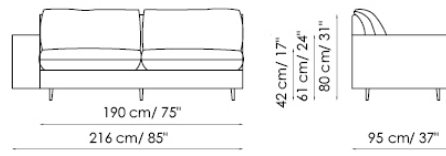

Terminale 201  
End section sofa

sx  
left

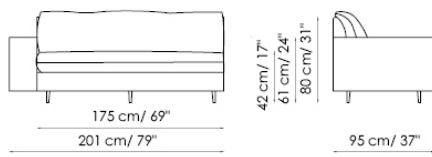

Centrale 270  
Center section

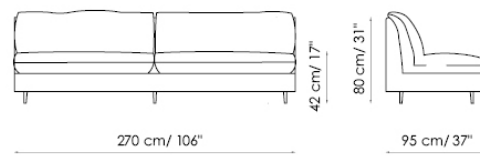

Centrale 230  
Center section

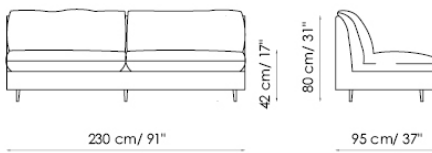

Centrale 190  
center section

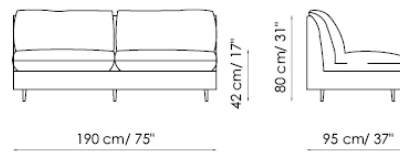

Centrale 175  
Center section

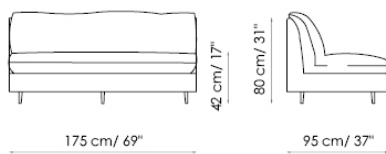

Centrale 155  
Center section

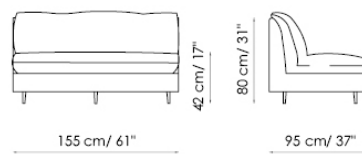

Centrale 135  
Center section

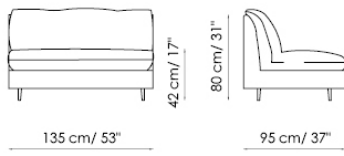

Centrale 115  
center section

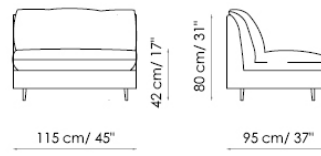

Centrale 95  
center section

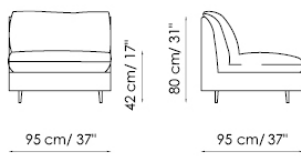

Chaise longue  
sx  
left

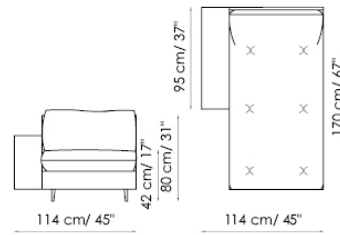

isola  
sx  
left

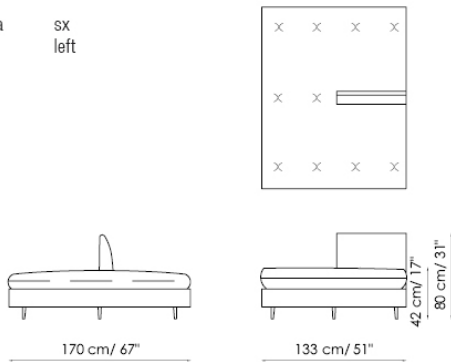

Pouf 95x95

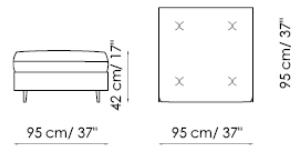

Pouf tavolino  
pouf small table

