



' vol. 1 **SOFAS AND SEATING SYSTEMS**

SOFAS and SEATING ELEMENTS for COMPOSITIONS

Injected flame-retardant polyurethane foam and polyester fiber over internal steel frame.
Feet in varnished steel powder coated. Polypropylene glides.
Cushions in polyurethane foam in varied densities and polyester fiber.
Bold collection covers are removable.

' vol. 1 **DIVANI E SISTEMI DI SEDUTE**

DIVANI ed ELEMENTI DI SEDUTA per COMPOSIZIONI
Espanso schiumato a freddo ignifugo e fibra poliesteri
con struttura interna in acciaio.

Piedi in acciaio verniciato a polveri.

Sottopiedi in polipropilene.

I cuscini sono in poliuretano espanso a densità differenziate e fibra poliesteri.

La collezione Bold è sfoderabile.

Design **Patricia Urquiola - 2015**



Recommended fabric hangers

Tirelle e tessuti consigliati

121-Elastic Fantastic 1 by Febrik
-Divina

Feet colors - Colori piedi



RAL 7006
mud



RAL 3009
oxidored



RAL 7016
anthracite



DARK BRONZE
high gloss

Sofa

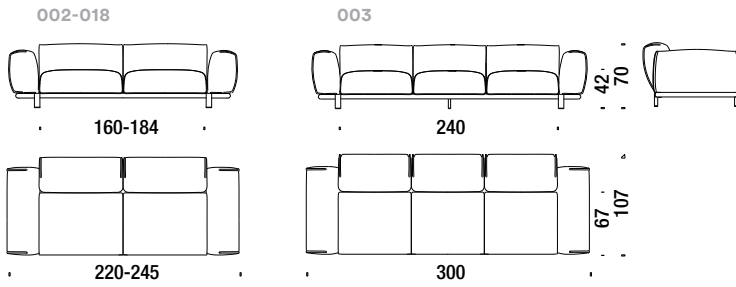

Ottoman

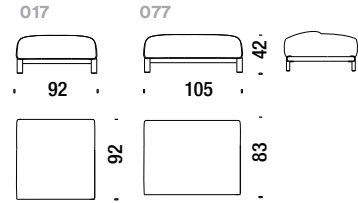

Elements

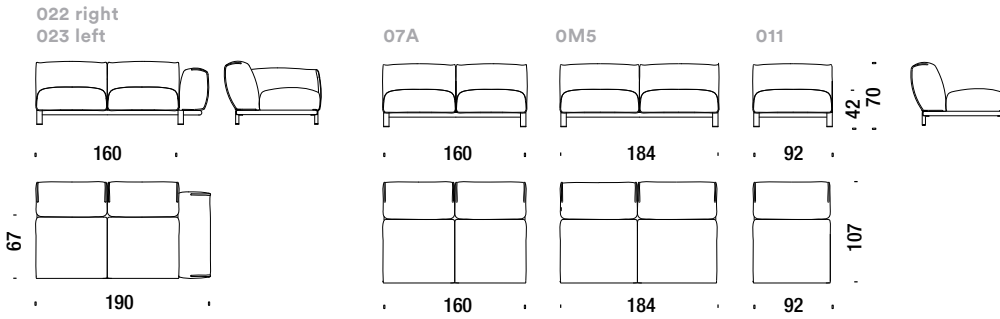

Peninsula

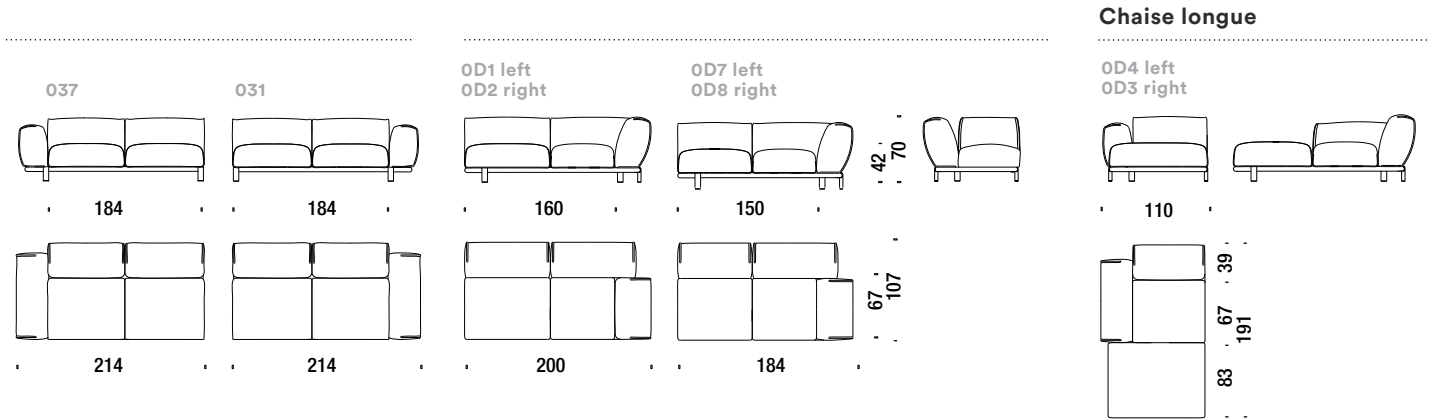
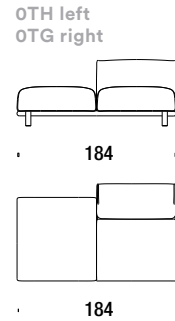

Example of composition

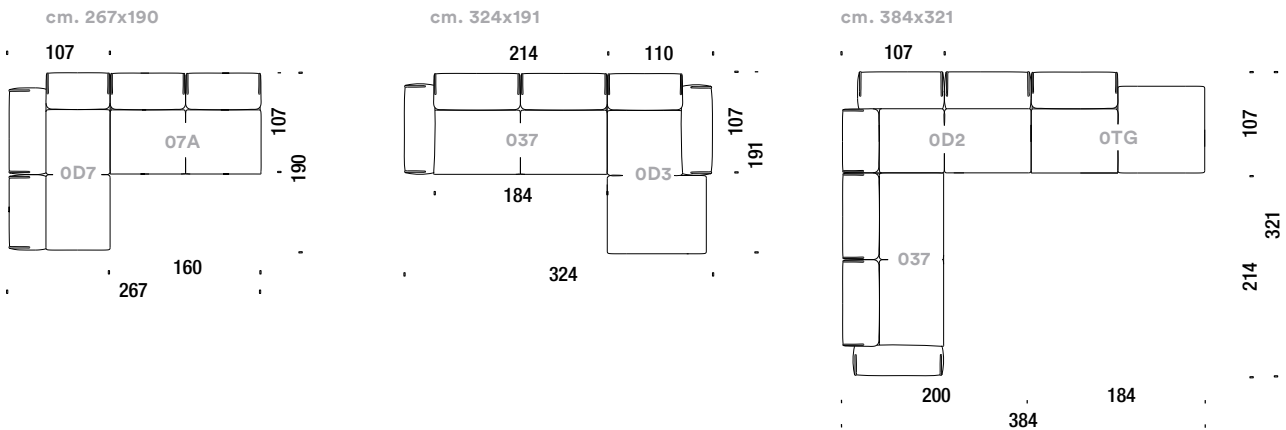

2 seater sofa

Divano 2 posti

002

12,3 mt. 23,5 m² 2 m³ 92 Kg

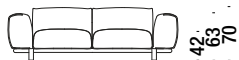

160

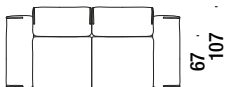

220

2 seater sofa major

Divano 2 posti major

018

12,8 mt. 24,2 m² 2,2 m³ 102 Kg



184



245

3 seater sofa

Divano 3 posti

003

16,1 mt. 30,5 m² 2,8 m³ 120 Kg



240

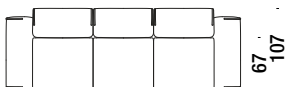

300

Stool 92x92

Pouf 92x92

017

4 mt. 7,5 m² 0,4 m³ 34 Kg

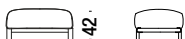

92

92

Stool large 105x83

Pouf grande 105x83

077

4,2 mt. 7,9 m² 0,5 m³ 40 Kg

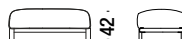

83

105

1 seater element

Elemento 1 posto centrale

011

6 mt. ★ 11,3 m² 0,9 m³ 50 Kg

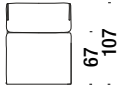
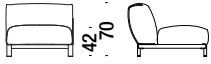

92

2 seater element

Elemento 2 posti centrale

07A

9 mt. ★ 17,2 m² 1,5 m³ 60 Kg

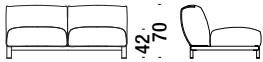

160

2 seater element major

Elemento 2 posti centrale major

0M5

9,5 mt. ★ 18 m² 1,7 m³ 70 Kg



184

Lateral 2 seat unit left

Elemento 2 posti sinistro

023

10,7 mt. ★ 20,2 m² 1,8 m³ 70 Kg



160



190

Lateral 2 seat unit right

Elemento 2 posti destro

022

10,7 mt. ★ 20,2 m² 1,8 m³ 70 Kg

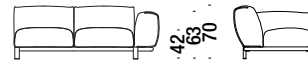

160

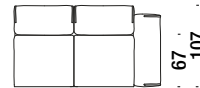

190

Lateral 2 seat unit major left

Elemento 2 posti major sinistro

037

11,2 mt. ★ 21,1 m² 2 m³ 80 Kg

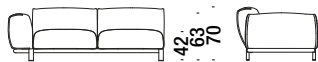

184



214

Lateral 2 seat unit major right

Elemento 2 posti major destro

031

11,2 mt. ★ 21,1 m² 2 m³ 80 Kg

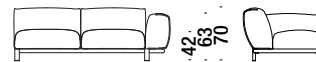

184

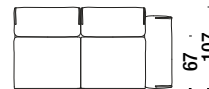

214

Lateral 2 seat left peninsula

Penisola 2p sinistra

OTH

8,6 mt. ★ 16 m² 1,7 m³ 65 Kg

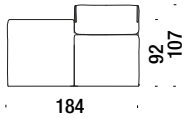
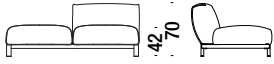

Lateral 2 seat right peninsula

Penisola 2p destra

OTG

8,6 mt. ★ 16 m² 1,7 m³ 65 Kg

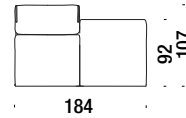
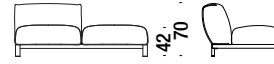

Left short corner 2 seat

Angolo 2 posti corto sinistro

OD7

10,7 mt. ★ 20,2 m² 1,7 m³ 70 Kg

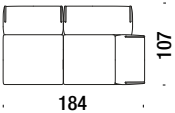
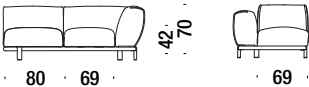

Right short corner 2 seat

Angolo 2 posti corto destro

OD8

10,7 mt. ★ 20,2 m² 1,7 m³ 70 Kg

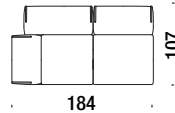
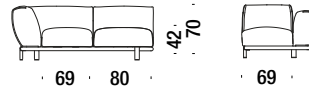

Left corner 2 seat

Angolo 2 posti sinistro

OD1

11,3 mt. ★ 21,1 m² 1,8 m³ 80 Kg

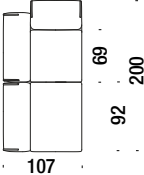
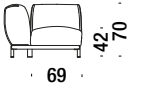

Right corner 2 seat

Angolo 2 posti destro

OD2

11,3 mt. ★ 21,1 m² 1,8 m³ 80 Kg

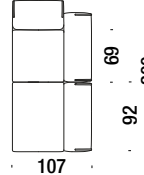
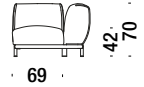

Chaise Longue left

Chaise Longue sinistra

OD4

9,9 mt. ★ 18,8 m² 1,7 m³ 75 Kg

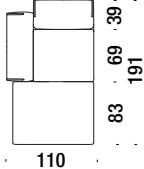
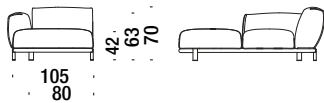

Chaise Longue right

Chaise Longue destra

OD3

9,9 mt. ★ 18,8 m² 1,7 m³ 75 Kg

