



' vol. 1 **SOFAS and SEATING SYSTEMS**

SOFAS and SEATING ELEMENTS for COMPOSITIONS
Flame-retardant polyurethane foam, polyester fiberfill and memory foam chips on extruded aluminum frame. Feet are die-cast aluminum with powder coat finish. Fabric covers only, belts in leather.

Belt collection covers are removable.

' vol. 1 **DIVANI E SISTEMI DI SEDUTE**

DIVANI ed ELEMENTI DI SEDUTA per COMPOSIZIONI
Imbottiture in poliuretano espanso ignifugo, fibra poliestere e chip di memory foam. Struttura in alluminio estruso e piedi in fusione di alluminio verniciato a polveri.
Rivestimenti solamente in tessuto con cinture in pelle.
La collezione Belt è sfoderabile.

Design Patricia Urquiola - 2016



Recommended fabric hangers

Tirille e tessuti consigliati

121-Elastic Fantastic 1 by Febrik
-Divina

COLOUR SET - ABBINAMENTI

feet colours colori piedi



**NCS S
7010-Y90R**
cacao



Pant. 5463
ink



RAL 3009
oxidored



RAL 7016
anthracite



RAL 7030
stone gray

belt colours colori cinture



cocoa
B0235 Z



ginger
B0198 Z

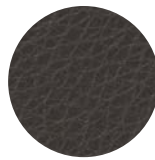

aubergine
B0208 Z



blush cirè
B0218 Z

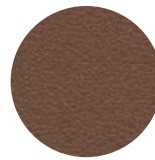

rust
B210 Z

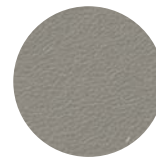

cocoa
B0199 Z

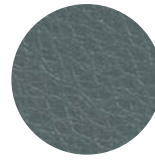

storm grey
B0200 Z

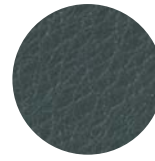

lake
B0202 Z

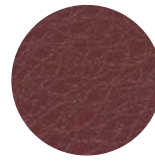

laquer cirè
B0217 Z

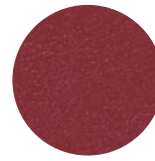

red
B0254 Z



rouge
B0206 Z

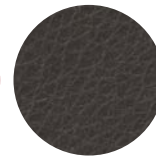

aubergine
B0208 Z

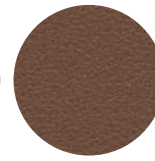

rust
B0210 Z

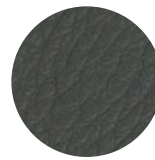

zingo
B0221 Z

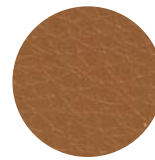

spice
B0234 Z



rouge
B0206 Z

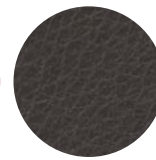

aubergine
B0208 Z

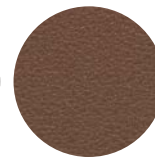

rust
B0210 Z

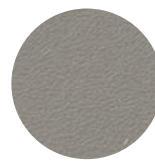

cocoa
B0199 Z

Sofa

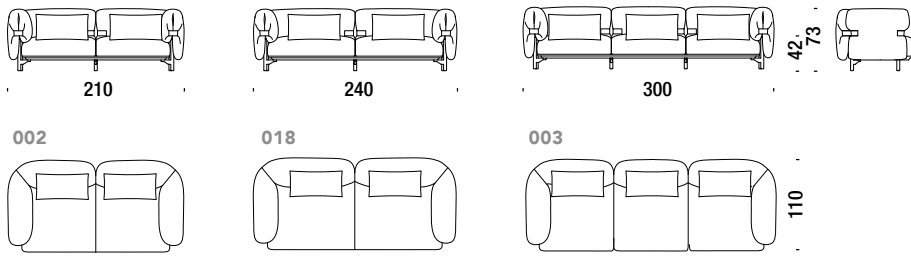

Example of composition

cm. 310x200

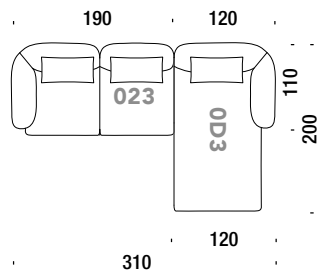

cm. 335x225

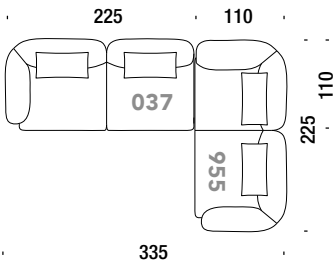

cm. 300x300

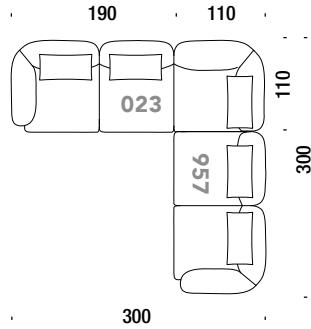

cm. 300x335

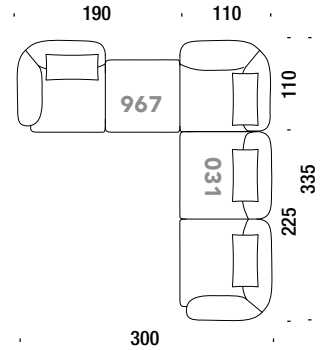

Element

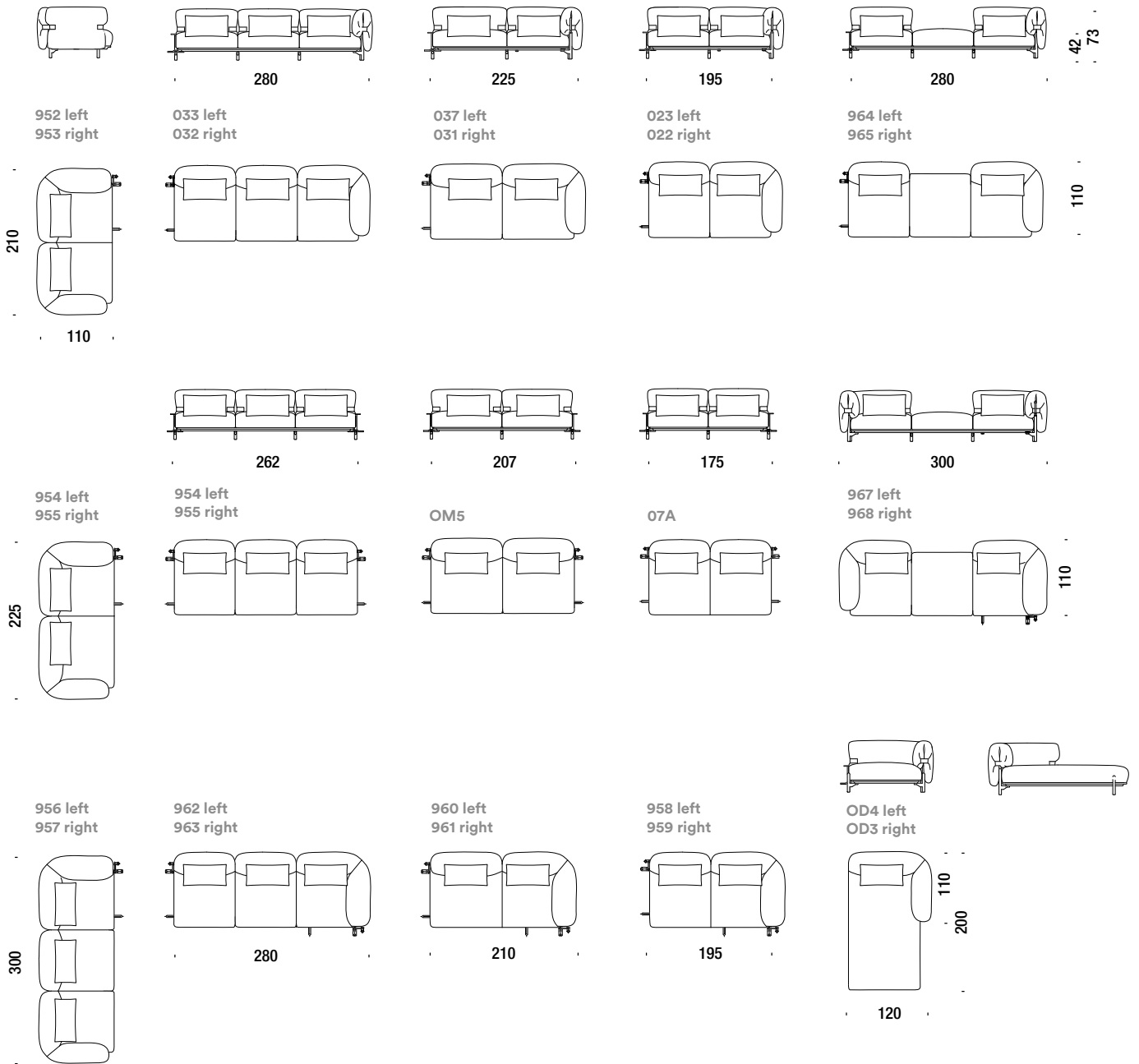

2 seater sofa 210

Divano 2 posti 210

002

10,3 mt. 1,9 m³ 70 Kg

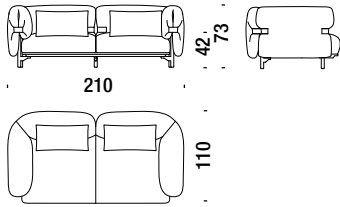

2 seater sofa major 240

Divano 2 posti major 240

018

11,6 mt. 2,1 m³ 85 Kg

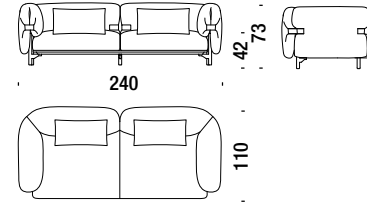

3 seater sofa 300

Divano 3 posti 300

003

14,1 mt. 2,5 m³ 100 Kg

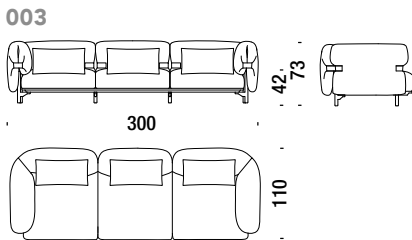

Optional back cushion

Cuscino poggiareni optional

753

0,9 mt. 0,5 Kg



2 seater central element 175x110

Elemento 2 posti centrale 175x110

07A

6,3 mt. 1,5 m³ 50 Kg

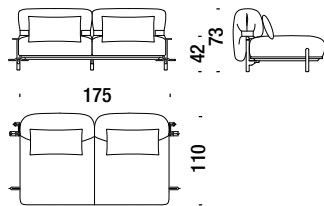

2 seater central major element 207x110

Elemento 2 posti centrale major 207x110

0M5

7,6 mt. 1,8 m³ 65 Kg

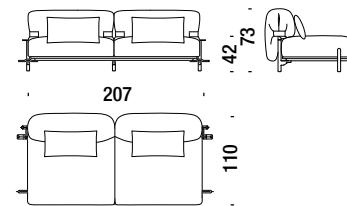

3 seater central element 262x110

Elemento 3 posti centrale 262x110

0W9

10,1 mt. 2,3 m³ 90 Kg

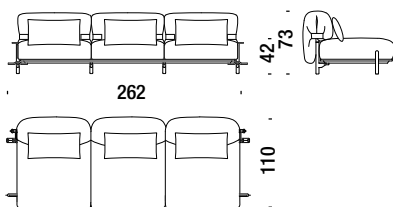

Lateral 2 seat unit left 190x110

Elemento 2 posti sinistro 190x110

023

8,3 mt. 1,7 m³ 65 Kg

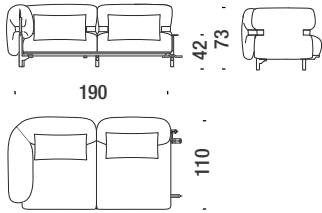

Lateral 2 seat unit right 190x110

Elemento 2 posti destro 190x110

022

8,3 mt. 1,7 m³ 65 Kg

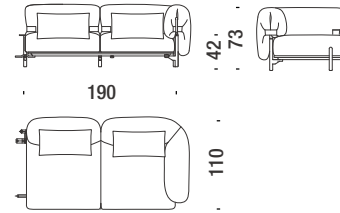

Lateral 2 seat unit major left 225x110

Elemento 2 posti major sinistro 225x110

037

9,6 mt. 1,9 m³ 80 Kg

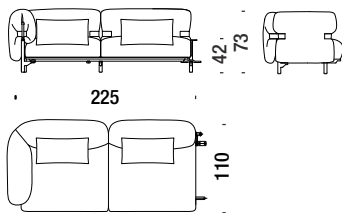

Lateral 2 seat unit major right 225x110

Elemento 2 posti major destro 225x110

031

9,6 mt. 1,9 m³ 80 Kg

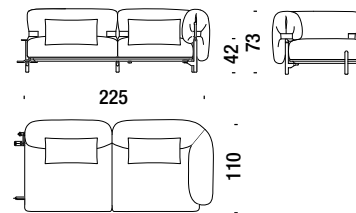

Lateral 3 seat unit left 280x110

Elemento 3 posti sinistro 280x110

033

12,1 mt. 2,4 m³ 90 Kg

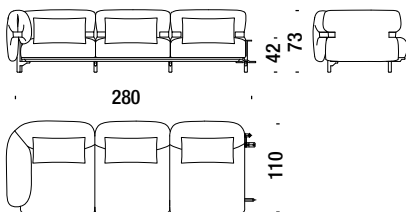

Lateral 3 seat unit right 280x110

Elemento 3 posti destro 280x110

032

12,1 mt. 2,4 m³ 90 Kg

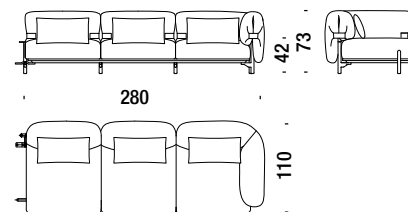

Chaise Longue left 120x200

Chaise Longue sinistra 120x200

0D4

9 mt. 1,9 m³ 70 Kg

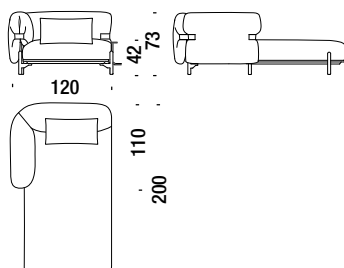

Chaise Longue right 120x200

Chaise Longue destra 120x200

0D3

9 mt. 1,9 m³ 70 Kg

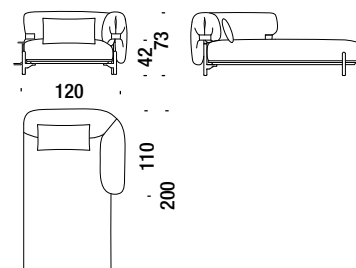

Left closed corner 2 seat 210x110

Angolo chiuso 2 posti sinistro 210x110

952

10,3 mt. 1,9 m³ 70 Kg

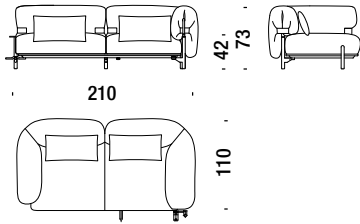

Right closed corner 2 seat 210x110

Angolo chiuso 2 posti destro 210x110

953

10,3 mt. 1,9 m³ 70 Kg

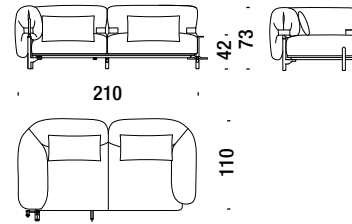

Left closed corner 2 seat major 225x110

Angolo chiuso 2 posti major sinistro 225x110

954

11,6 mt. 1,9 m³ 85 Kg

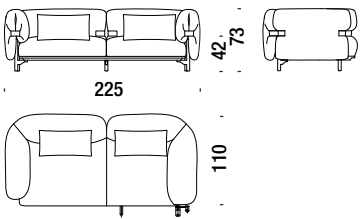

Right closed corner 2 seat major 225x110

Angolo chiuso 2 posti major destro 225x110

955

11,6 mt. 1,9 m³ 85 Kg

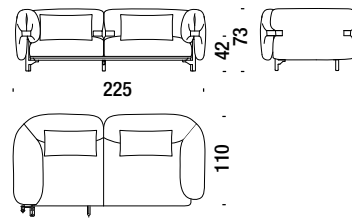

Left closed corner 3 seat 300x110

Angolo chiuso 3 posti sinistro 300x110

956

14,1 mt. 2,5 m³ 100 Kg

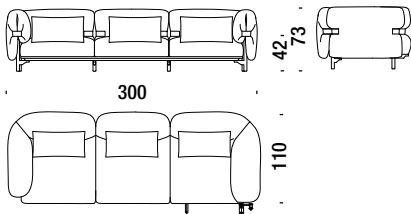

Right closed corner 3 seat 300x110

Angolo chiuso 3 posti destro 300x110

957

14,1 mt. 2,5 m³ 100 Kg

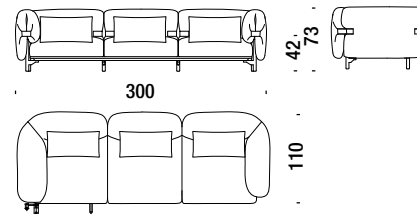

Left open corner 2 seat 195x110

Angolo aperto 2 posti sinistro 195x110

958

8,3 mt. 1,7 m³ 80 Kg

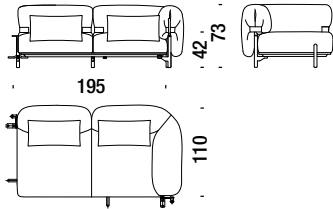

Right open corner 2 seat 195x110

Angolo aperto 2 posti destro 195x110

959

8,3 mt. 1,7 m³ 80 Kg

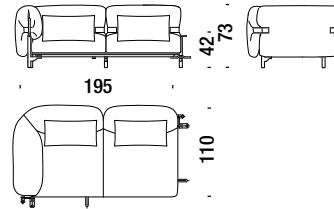

Left open corner 2 seat major 210x110

Angolo aperto 2 posti major sinistro 210x110

960

9,6 mt. 1,8 m³ 85 Kg

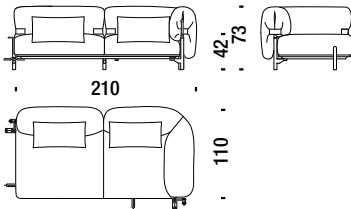

Right open corner 2 seat major 210x110

Angolo aperto 2 posti major destro 210x110

961

9,6 mt. 1,8 m³ 85 Kg

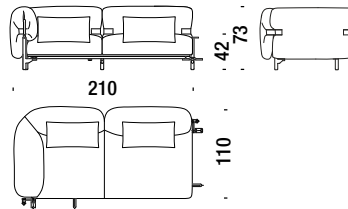

Left open corner 3 seat 280x110

Angolo aperto 3 posti sinistro 280x110

962

12,1 mt. 2,4 m³ 90 Kg

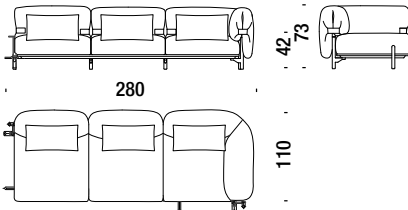

Right open corner 3 seat 280x110

Angolo aperto 3 posti destro 280x110

963

12,1 mt. 2,4 m³ 90 Kg

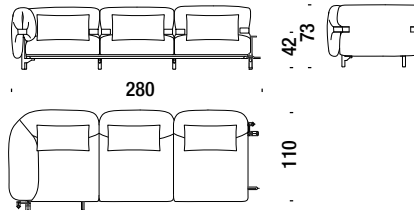

Lateral 3 seat left without backrest 280x110

Elemento 3 posti sinistro senza schienale 280x110 964

12,1 mt. 2,4 m³ 85 Kg

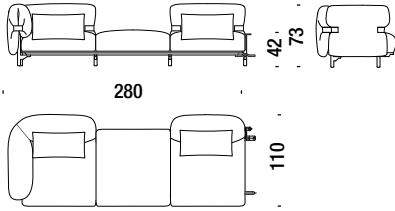

Lateral 3 seat right without backrest 280x110

Elemento 3 posti destro senza schienale 280x110 965

12,1 mt. 2,4 m³ 85 Kg

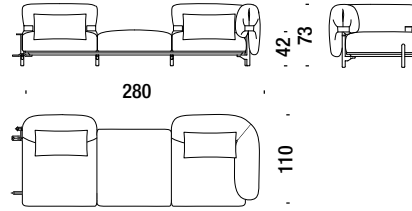

Left closed corner 3 seat without backrest 300x110

Angolo chiuso 3p sinistro senza schienale 300x110 967

11,6 mt. 2,5 m³ 95 Kg

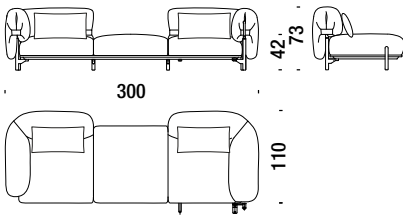

Right clos.corner 3 seat without backrest 300x110

Angolo chiuso 3p destro senza schienale 300x110 968

11,6 mt. 2,5 m³ 95 Kg

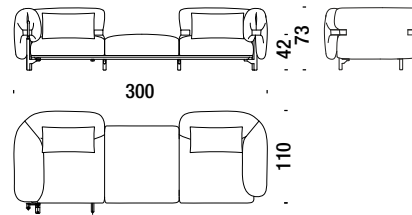

Left open corner 3 seat without backrest 280x110

Angolo aperto 3p sinistro senza schienale 280x110 969

12,1 mt. 2,4 m³ 85 Kg

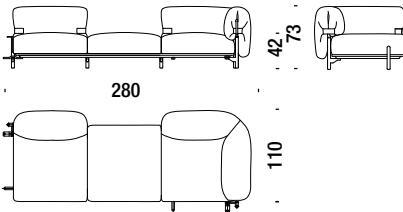

Right open corner 3 seat without backrest 280x110

Angolo aperto 3p destro senza schienale 280x110 970

12,1 mt. 2,4 m³ 85 Kg

